

SIEMENS

Quick Reference Guide

Optiset E Standard, Advance Plus, and Memory

for Hicom 150 E, OfficePoint,
OfficeCom, and OfficePro

Version 1.0

WARNING!

Hackers who unlawfully gain access to customer telecommunication systems are criminals. Currently, we do not know of any telecommunications system that is immune to this type of criminal activity. Siemens Business Communication Systems, Inc. will not accept liability for any damages, including long distance charges, which result from unauthorized use. Although Siemens Business Communications has designed security features into its products, it is your sole responsibility to use the security features and to establish security practices within your company, including training, security awareness, and call auditing.

Siemens Business Communications sales and service personnel, as well as Siemens Business Communications business partners, are available to work with you to help you prevent this type of unauthorized use of your telecommunications system.

NOTE: The Siemens Optiset telephones for Hicom 150 E systems are hearing-aid compatible and comply with the applicable FCC Rules, Part 68, and Industry Canada CS-034 standard.

This equipment has been tested and found to comply with the limits for a Class B digital device, pursuant to Part 15 of the FCC Rules. These limits are designed to provide reasonable protection against harmful interference in a residential installation. This equipment generates, uses and can radiate radio frequency energy and, if not installed and used in accordance with the instructions, may cause harmful interference to radio communications. However, there is no guarantee that interference will not occur in a particular installation. If this equipment does cause harmful interference to radio or television reception, which can be determined by turning the equipment off and on, the user is encouraged to try to correct the interference by one or more of the following measures:

- Reorient or relocate the receiving antenna.
- Increase the separation between the equipment and receiver.
- Connect the equipment into an outlet on a circuit different from that to which the receiver is connected.
- Consult the dealer or an experienced radio/TV technician for help.

WARNING: Changes or modifications to the equipment that are not expressly approved by the responsible party for compliance could void the user's authority to operate the equipment.

This equipment does not exceed Class B limits per radio noise emissions for digital apparatus, set out in the Radio Interference Regulation of the Canadian Department of Communications. Operation in a residential area may cause unacceptable interference to radio and TV reception requiring the owner or operator to take whatever steps are necessary to correct the interference.

Cet équipement ne dépasse pas les limites de Classe B d'émission de bruits radioélectriques par les appareils numériques, telles que prescrites par le Règlement sur le brouillage radioélectrique établi par le ministère des Communications du Canada. L'exploitation faite en milieu résidentiel peut entraîner le brouillage des réceptions radio et télé, ce qui obligerait le propriétaire ou l'opérateur à prendre les dispositions nécessaires pour en éliminer les causes.

September 1998

Form No. G281-0462-01 Part No. 06E0352ECNo. A93049

Job No. 4597

No part of this publication may be reproduced, stored in a retrieval system, or transmitted, in any form or by any means, mechanical, electronic, photocopying, recording, or otherwise, without prior written permission of Siemens Business Communication Systems, Inc.

Request Siemens publications from your Siemens representative or the Siemens branch serving you. Publications are *not* stocked at the address below.

Siemens Business Communication Systems, Inc.
4900 Old Ironsides Drive
P.O. Box 58075
Santa Clara, CA 95052-8075
(408) 492-2000

Siemens, Optiset, and PhoneMail are registered trademarks and Hicom is a trademark of Siemens Aktiengesellschaft.
Copyright Siemens Business Communication Systems, Inc. 1998. All rights reserved.

Contents

Welcome to Your Optiset E Standard, Advance Plus, and Memory Telephones	1
Optiset E Standard Telephone	2
Optiset E Advance Plus Telephone	3
Optiset E Memory Telephone	4
Bay Option Modules	6
Optiset E Local Power Supply	10
Where to Go for Assistance	11
Your Class of Service	11
Status Lights	11
The OptiGuide Display	12
Feature Keys and Access Codes	14
Setting up Your Telephone	14
Volume Keys	15
Sounds	16
Changing Your Audio Settings	17
Callback Request	18
Caller List	19
Conference	20
Consultation	23
Directed Call Pickup	24
Forwarding	25
Hold	26
Hold—Internal Consultation	27
Last Number Redial—Expanded	28
Mailbox / Text Messages	29
Park	31
Pickup	32
Repertory Dialing (Repdial) Keys	33
Saved Number Redial	34
Speakerphone	35
Station / Individual Speed Dialing	36
System Speed Dialing	37
Transfer	38
Feature Access Codes	39
Index	I-1
Quick Reference Guide to Optiset Phones	A-1

Welcome to Your Optiset E Standard, Advance Plus, and Memory Telephones

The Optiset[®] E Standard, Advance Plus, and Memory digital telephones work with your company's Siemens[®] Hicom[®] 150 E Communications Server to give you advanced, easy-to-use telephone features. (The communications server is your company's internal telecommunications system.)

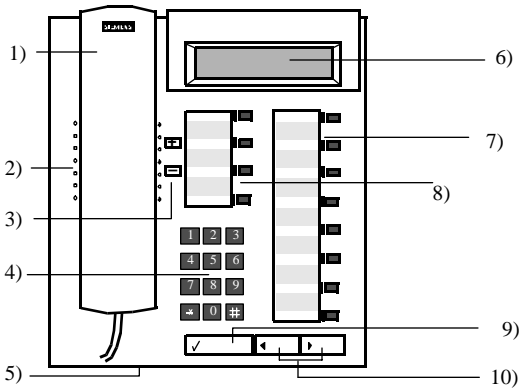

Figure 1. Optiset E Standard and Advance Plus Telephones

- 1) Handset
- 2) Speaker (ringing tone/open listening)
- 3) Volume keys for telephone settings
- 4) Key pad
- 5) Microphone for handsfree talking
- 6) Display with 2 lines, 24 characters each
- 7) Programmable feature keys
- 8) Default feature keys
- 9) Select OptiGuide key (confirms selection)
- 10) Scroll Forward and Scroll Back OptiGuide keys (for browsing)

Optiset E Standard Telephone

The Optiset E Standard telephone has a microphone for a two-way speakerphone and does not support user-installable option modules. The Standard and Advance Plus telephones have four default feature keys for the Program/Service, Redial, Mute, and Speakerphone features. In addition, the eight programmable feature keys can be used as either Redial keys or user-preferred, commonly accessed feature keys. There is a two-line tiltable display for viewing user prompts and the current telephone settings.

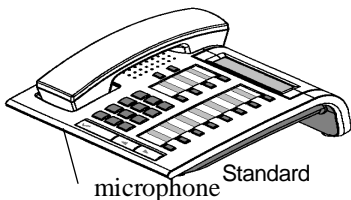

Figure 2. Optiset E Standard Telephone

Optiset E Advance Plus Telephone

The Optiset E Advance Plus telephone has two bays underneath the base of the telephone for any of the following user-installable option modules:

- Optiset E Analog Adapter
- Optiset E Data Adapter
- Optiset E Headset Adapter
- Optiset E Headset Plus Adapter
- Optiset E ISDN Adapter
- Optiset E Phone Adapter
- Optiset E Control Adapter

The Optiset E Advance Plus telephones also support up to four, side-mounted Optiset E Key Module options, for a total of 64 additional feature keys and up to 29 line extensions. The Optiset E Advance Plus telephone also has a microphone for a two-way speakerphone.



Figure 3. Optiset E Advance Plus Telephone

Optiset E Memory Telephone

The Memory telephone has a microphone for a two-way speaker telephone. Two bays for optional adapters are under the telephone. This telephone has an eight-line, tiltable display with up to 24 characters per line.

The Memory telephone has four default feature keys for the Program/Service, Redial, Mute, and Speakerphone features. There are eight programmable feature keys that can be used as either Redial keys or user-preferred, commonly accessed feature keys, and there are three OptiGuide™ keys for working with the Siemens OptiGuide display.

The Memory telephone has an alphanumeric keyboard used for entering text in situations like programming names on stations, sending custom text messages, and for entering names and extensions in the Electronic Notebook included with the telephone. The Electronic Notebook feature is used to store a directory of data such as names, telephone numbers, and telephone system features.

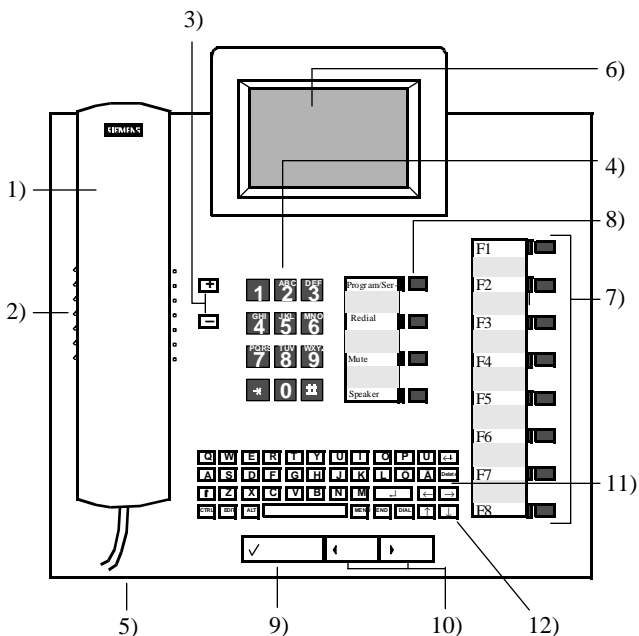

Figure 4. Optiset E Memory telephone

Features on the Memory Telephone

- 1) Handset
- 2) Speaker under handset (ringing tone/open listening)
- 3) Volume keys for telephone settings
- 4) Key pad
- 5) Microphone for handsfree talking
- 6) Tilttable display with 8 lines, 24 characters each
- 7) Programmable feature keys
- 8) Default feature keys
- 9) Select OptiGuide key (confirms selection)
- 10) Scroll Forward and Scroll Back OptiGuide keys (for browsing)
- 11) Keyboard for message texts
- 12) Cursor keys (for additional functions)

Bay Option Modules

The bay option modules snap into place in the bays underneath the Advance Plus and Memory telephones. They are the same size and shape, but labels clearly identify their type.

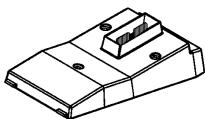

Figure 5. Bay Option Modules

Optiset E Analog Adapter

The Analog Adapter lets you attach a standard analog device, such as a telephone, facsimile machine, modem, or answering machine, to your telephone via an RJ11 connector on the back of the adapter. The attached device is configured at your communications server to be completely independent, with its own telephone number. It can be attached to a standard telephone cable up to 300 ft. long. This adapter requires the Optiset E Local Power Supply for operation. (See “Optiset E Local Power Supply” on page 10.)

Optiset E Data Adapter

The Data Adapter lets you connect your telephone to a computer or terminal via a 25-pin connector for an EIA-232-E cable. You can make asynchronous data calls by issuing AT commands from your attached PC or terminal to your telephone, much as you would to an attached modem. This adapter supports baud rates of up to 38.4 kilobytes per second (autobaud detection), simultaneous voice and data communication, hardware flow control (RTS/CTS), and full duplex operation. It also supports the Siemens Application Programming Interface (API), data loopback for customer service tests, and V.120 and DMI mode 2-Bit Rate Adaptation.

Optiset E Headset Adapter

The Headset Adapter lets you plug one or two electret microphone-type headsets into your telephone. You can then make and answer calls using a headset instead of the handset or the telephone’s built-in microphone and speaker. This type of

headset does not require an amplifier. Connection is made through two RJ8 connectors. Only the Optiset E Advance Plus and Memory telephones support this option. When a headset is plugged into the adapter, the speakerphone does not function.

Optiset E Headset Plus Adapter

The Optiset E Headset Plus Adapter lets you plug one or two carbon microphone-type headsets and a recorder into your telephone. You can then make and answer calls handsfree by using a headset instead of the handset or the telephone's built-in microphone and speaker.

This type of headset requires an amplifier. You can also record your conversations. The headsets attach to two RJ8 connectors. The recorder attaches to an RJ11 connector. Only the Optiset E Advance Plus and Memory telephones support this option. When a headset is plugged into the adapter, the speakerphone does not function. The recorder works without a headset being plugged in.

Optiset E ISDN Adapter

The ISDN Adapter lets you connect ISDN S₀ bus devices such as telephones, PC cards, LAN Bridges, G4 fax machines, and video equipment to your telephone via an RJ45 connector. It supports up to 64 kilobytes per second simultaneously on each bearer channel. It will only work properly in a primary telephone, not in a telephone attached to another telephone with the Phone Adapter. You can only connect two ISDN devices to the adapter.

Optiset E Phone Adapter

The Phone Adapter lets you attach another Optiset E telephone to your Basic telephone. It provides an RJ11 connector; you can attach the second telephone via a standard telephone cable up to 300 feet long. You can then place the second telephone in an area not wired for a telephone. The attached telephone is configured at your communications server to be a completely independent telephone with its own telephone number.

Optiset E Control Adapter

The Optiset E Control Adapter (TA Control) lets you connect a PC and a headset to an Optiset E telephone (except Optiset E Entry and Optiset E Basic). The Optiset E Control Adapter operates in both API1 mode and API2 mode.

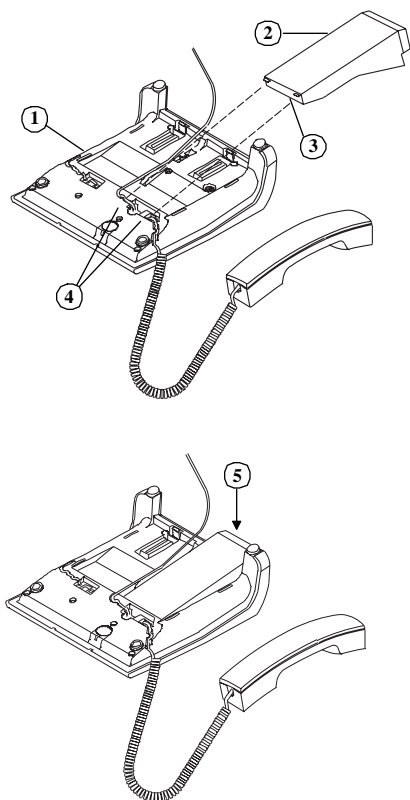

Figure 6. Installation of Bay Option Modules

To install a bay option module

1. Disconnect the telephone line from the wall jack or telephone and place the telephone ① on a soft surface with the keypad facing down.
2. Hold the adapter ② with the plug connector strip facing down and mount it in one of the two mounting locations on the bottom of the telephone, sliding the two tabs ③ into the two slots ④.
3. Gently press down on the adapter until the plug connector strip is inserted all the way into the socket connector strip ⑤.

For the **Analog Adapter**, connect an analog device to the 6-pin RJ11 port on the back of the Analog Adapter (connecting tip/ring to pins 3 and 4). Reconnect the telephone line to the telephone. Note, the analog adapter requires the Optiset E Local Power Supply for operation.

For the **Data Adapter**, connect the data terminal equipment to the 25-pin (EIA-232) connector on the back of the Data Adapter. Reconnect the telephone line to the telephone.

For the **Headset Adapter**, connect the headset to the headset (RJ8) connector on the adapter. Reconnect the telephone line to the telephone.

For the **Headset Plus Adapter**, connect the headset to the headset (RJ8) connector on the adapter. Connect the recorder to the recorder (RJ11) connector. Reconnect the telephone line to the telephone.

For the **ISDN Adapter**, connect the ISDN terminal to the RJ45 adapter. Reconnect the telephone line to the telephone.

For the **Phone Adapter**, connect the secondary Optiset E telephone into the RJ11 connector on the adapter. Reconnect the telephone line to the telephone.

For the **Control Adapter**, connect the headset to the headset (RJ8) connector on the adapter. Connect the PC from the serial port on the PC to the (RS232) connector on the adapter. Reconnect the telephone line to the telephone.

Optiset E Key Module

The side-mounted Optiset E Key Module adds 16 keys for features and line appearances. Up to four Optiset E Key Modules can be linked together on one telephone for a total of 64 additional feature keys and up to 29 line appearances. Only the Optiset E Advance Plus and Memory telephones support this option. Wall mount kits do not support telephones with an Optiset E Key Module attached.

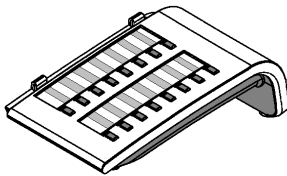



Figure 7. Optiset E Key Module

Optiset E Local Power Supply

The Local Power Supply is required for the Analog Adapter. It may also be required in other situations, depending on the Optiset E telephone's configuration, the type of telephone cable used, the length of the telephone cable from the communications server, and the type of communications server used. Only one Optiset E Local Power Supply can be used at a time on an Optiset E telephone. However, one Local Power Supply can be used on a primary telephone and a second Local Power Supply can be used on a secondary telephone attached to the primary telephone through a Phone Adapter.

Installation of Local Power Supply

To install a local power supply:

1. Disconnect the telephone line from the wall jack and the telephone. New telephones should have a line cord attached to the telephone, but may not be plugged into the wall jack. Plug the line cord (PN 51A4871) ① that comes with the power supply into the jack on the telephone and into the jack on the power supply labeled .
2. Plug one end ② of the line cord that you disconnected from the telephone into the jack on the power supply labeled .
3. Plug the other end ③ of this line cord into the wall jack. Note, you could also plug it into an Optiset E Phone Adapter installed in another properly installed telephone.
4. Plug the power supply ④ into a properly grounded 120 Vac electrical outlet.

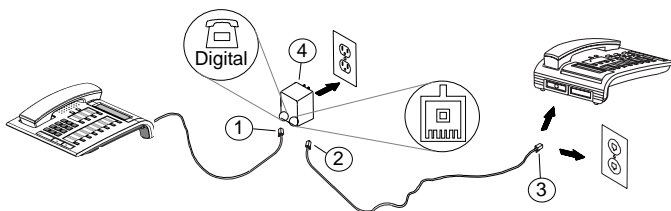

Where to Go for Assistance

Although every company has its own way of handling support for Optiset E telephones, most have a person responsible for making configuration changes and answering questions about the telephone system. This person, the system administrator, can provide you with information on the features you need to use and can help troubleshoot problems with your telephone when necessary. For more detailed information about your telephone's features and operation, refer to the *Optiset E Telephones for Hicom 150 E, Administrator Guide* (G281-0460-00).

Your Class of Service

Each telephone in your Siemens telephone system has a class of service (COS) specifying the features available to it. Therefore, you may find that some features included in this guide are not available on your telephone. Ask your system administrator about the features assigned to your telephone.

Status Lights

The red status lights next to the feature keys tell you the idle, busy, or in-transit status of calls on those keys. A feature key status light may turn on steadily, blink, or flash at different rates to signal the status of the line. Lights next to the feature keys may indicate the on/off status of that feature.

When the light is...	the line is...
Off	Available
On steady	In use
Blinking	On hold
Flashing (faster)	Ringling

The OptiGuide Display

The OptiGuide™ display provides information to help you use your telephone. The top line shows the time and date and call-related information such as the extension calling you.

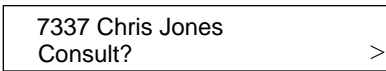

The second line indicates some of the features available to your telephone in its current state and provides prompts on how to use them. For example, when you are on a call, the prompt *Consult?* appears; this option lets you begin a private consultation call if you want. When the > symbol appears at the right of the display, more features are available for your telephone's current state. The second line also presents call-related information such as the duration of the current call. You can configure your telephone to display this line automatically or manually.



You can also use the OptiGuide display to show features you have activated, scroll through messages sent to your telephone, and change the audio settings on your telephone.





OptiGuide Keys

The three large keys at the bottom of the telephone are used to scroll through prompts and to select features.

- The  key (Scroll Forward) is used to scroll to the next option.
- The  key (Scroll Back) is used to scroll to the previous option.
- The  key (Select) is used to select or start the displayed feature or function.

After you have selected a feature, new prompts appear to help you complete the feature's operation.

Main Menu

To go to the main menu, press the Program/Service key. If your telephone is idle, you can also press  or . Next, use  or  to scroll to and select from the optional prompts. The prompts will vary in some cases, depending on whether your telephone is idle or active (when you have a dial tone or are on a call). If you know the code for the feature you want to access, you can enter it, rather than scrolling through the

lists of features. For a full list of features and codes see “Feature Access Codes” on page 39.

How to use this guide to access features

Since this is a quick reference guide, this manual does not attempt to describe every possible way to activate and deactivate every feature. In describing each feature, this manual uses the following criteria:

- If you can access the feature through the OptiGuide keys, the other methods for accessing the feature are not included.
- If you cannot access the feature through the OptiGuide keys (without using the Program/Service key), the other methods for accessing the feature are shown.
- For each feature section, there is a reference to the list of feature access codes on page 39. Once you are familiar with the system and aware of the access codes, you can easily activate features with the method you prefer best.
- The term *select* means to press the Select key.
- The term *scroll* means to press one of the Scroll keys.

Generally speaking, for all features with an on/off position, the * (star key) will turn the feature on and # (pound key) will turn it off.

This quick reference guide discusses how to use the most popular Optiset E Standard, Advance Plus, and Memory telephone features; for complete instructions on all of the features, please see the *Optiset E Telephones for Hicom 150 E Administrator Guide* (G281-0460-00).

Feature Keys and Access Codes

You can press feature keys to gain access to Siemens telephone system features such as Hold, Transfer, Mailbox, and Program/Service. By programming a feature key or dialing a feature access code, you can easily use any accessible feature without scrolling through the OptiGuide display.

This guide explains the basic steps for using many features. For accessing features through quick access codes refer to “Feature Access Codes” on page 39. Your system administrator may have configured both the acronyms for feature keys and the access codes differently from how they appear here.

Setting up Your Telephone

The first thing you will want to do is locate the default Program/Service key on your Optiset E telephone. The Program/Service key accesses many of the features on your Optiset E telephone. This key is the top default feature key (refer to “Welcome to Your Optiset E Standard, Advance Plus, and Memory Telephones” on page 1 for more information).

To program a feature key

1. From the Program/Service menu, scroll to and select *Program feature key?*

or dial * 91.

2. Press the feature key you want to change and select *Change key?* from the options menu.

Other options include:

Clear Key?





Another Key?



Exit?

3. Use the Select key to choose an option.
4. Exit. Don't forget to write the name of the feature on the face plate next to the key.

Refer to “Feature Access Codes” on page 39 for information on accessing features through special access codes.

Volume Keys

Use the Volume Up  and Volume Down  keys to adjust the voice volume of your telephone. While on a call, press  to raise the volume, or press  to lower it until you reach the desired volume level.

When you hang up or switch to another call, the volume returns to the original level. To retain your new settings, press the  (Select) key or the  and  keys together before hanging up or switching to another call.

Sounds

Your telephone makes different sounds to indicate what is going on. Rings occur on free lines, indicating an incoming call. Tones occur while you are using your telephone and provide information about calls and features.

Table 1: Rings







Sound	Meaning
Single (repeated)	Internal call
Double (repeated)	External call
Triple (repeated)	Callback

Table 2: Tones

Sound	Meaning
Busy tone	The party you dialed is on the telephone.
Dial tone	You can make a call or invoke a feature.
Fast busy tone	Invalid call.
Short tone every 20 sec.	Internal call waiting.
3 short tones (confirmation tone)	A feature has been successfully activated.
3 short tones followed by dial tone	Additional input, such as a PIN, is required.
2 short tones every 20 secs.	External call waiting.
Wavering (error) tone	Invalid feature request.

Changing Your Audio Settings

To change the audio settings on your telephone:

1. Press the  key to display the *Configure Telephone* option.
2. Scroll through and select from the following options:
Ring volume?
Ring tone?
Speakerphone mode?
3. Use the   keys to select the option that you want to adjust.
4. Use the  and  keys to raise or lower the volume, tone, or microphone sensitivity.
5. Press the  (select) key to save and exit.

Callback Request

Callback Request has the communications server help you complete calls to busy, ringing, or Do Not Disturb extensions. It lets you hang up and have the communications server call you back with triple rings when the extension is available. When you then answer, the communications server automatically dials the number.

Note: You can only make two callback requests from your telephone and only one callback request to the same destination.

To request a callback

1. Make a call and listen for the telephone to ring or for a busy signal.
2. Press the Select key to choose *Callback?*.
3. Hang up.
4. When the communications server calls back with triple rings, answer the telephone. The communications server will then callback the party that you called earlier.

To cancel a callback

If you initiate a callback request and then want to cancel it,

1. With the telephone idle, scroll to and select *View callbacks?*.
2. Select *Delete?*.
3. If you have more callback requests to cancel, scroll to and select *Next?*.
4. Select *Delete?*. Keep repeating these steps until all of the callbacks that you want cancelled are removed.

Refer to “Feature Access Codes” on page 39 for information on accessing features through special access codes.

Caller List

Caller list keeps track of your unanswered incoming calls in addition to saving any other calls that you add to the list. Using the list, you can quickly redial any internal/external caller that has called you, or you can redial numbers that you have added to your list.

Your caller list tracks all the unanswered calls to your extension, but if you answer the call, you must manually add the caller to the list.

To make calls with caller list

1. Use the scroll keys to find and select *Caller List?*. The display shows the name, extension number or telephone number (if available), and the number of calls from each caller.

2. Select a caller from the list.

Note: With a two-line display, select *Next?* to scroll through the caller list; however, with the Memory telephone, use the *Up* and *Down* cursor keys.

3. Scroll to *Call?* and select.

4. The communications server will automatically dial the extension.

To add callers to your caller list

While listening to ringing or during a call, scroll to *Save Number?* on your OptiGuide display. Select it, and the number will be automatically added to your caller list.

Note: When the symbols *OX* are displayed, it means that the call was added to the list manually.

Refer to “Feature Access Codes” on page 39 for information on accessing features through special access codes.

Conference

The Conference feature lets you have up to five internal or external parties, including yourself, in a telephone conversation.

Once a conference has begun, only the person who set it up may add or remove parties. That person is the conference master. If the conference master has left the conference, then the internal caller whom has been participating in the conference the longest will be the new conference master.

To set up a conference

1. During a call, scroll through the prompts on your OptiGuide display and select *Start conference?*. This places the other party on consultation hold.
2. Listen for dial tone, dial the extension you want to add, or dial 9 and the outside number.
3. After the party answers, scroll to and select *Conference?* from your OptiGuide display to join all the parties.

Types of parties you can add to a conference

You can add the following kinds of calls to conference calls:

- calls that you dial
- calls on busy standby queuing for the extension you are using (call waiting)
- calls parked in numbered system slots
- calls on hold on your telephone

To add an additional party to a conference

1. During a conference, select *Add party?*
2. Listen for dial tone, dial the extension you want to add, or dial 9 and the outside number.
3. After the party answers, scroll to and select *Conference?* from your OptiGuide display to join all the parties.

To add a waiting call to a conference

If you are engaged in a conference and you receive a signal that a call is waiting, you can receive the call and add it to the conference.

1. When you here the call waiting tone, accept the waiting call by selecting *Call waiting?*. This places the conference on hold and connects you with the caller.
2. Scroll to and select *Conference?* from your OptiGuide display to join all the parties.

To add a call in park to a conference

Note: You can easily park and retrieve parked calls by programming a Park key. Refer to “To program a feature key” on page 14 for more information on programming a feature key.

1. During a conference, scroll to and select *Add party?* to place the conference on consultation hold.
2. Press the Park key (if present).

or dial * 56.
3. Dial the system slot (0-9) where the parked call is located.
4. The parked party answers and consents to join the conference. Scroll to and select *Conference?*.
5. All parties hear a conference tone, signaling that another party has joined the conference.

To set up a conference call with a call on hold

1. After placing a caller on hold with a Hold key, dial the number of the conference party that you want add.
2. After the party answers, scroll to and select *Conference?* from your OptiGuide display to join all the parties.

Note: It is not necessary to place a caller on hold to start a conference. Normally, you would place a caller on consultation hold to begin a conference. This procedure is only documented because it is available to users as an option.

To reconnect to the conference when a called party does not want to join

Scroll to and select *Quit and return?*.

To drop a party

1. Scroll to *View conference parties?* and select it. Only the person who set up the conference may do this.
2. From this menu you use the cursor or scroll keys to select the option, *Remove party?*.
3. Select the party to be removed.

Refer to “Feature Access Codes” on page 39 for information on accessing features through special access codes.

Consultation

Consultation lets you put a call on consultation hold, so you can call and talk privately with a different party. You can then use the Toggle/Connect feature to alternate between the two parties.

To consult with a second party during a call

1. During a call, scroll through the prompts on your OptiGuide display and select *Consult?*.
2. Dial the other party's extension or 9 and the outside number.
3. Talk with the new party.

To reconnect with the first party

1. Scroll through the prompts on your OptiGuide display and select *Toggle/Connect?*.
2. You can continue to use the Toggle/Connect feature to alternate between the two parties.

To release a consulting party

1. While connected with the party, scroll through the prompts on your OptiGuide display and select *Quit and return?*.
2. The party will be released, and you will be connected to the first party.

Refer to "Feature Access Codes" on page 39 for information on accessing features through special access codes.

Directed Call Pickup

This feature lets you pickup calls from any extension.

Note: For the procedure described here, you must program a Pickup - directed key (refer to “To program a feature key” on page 14).

To pickup a call at an extension not in your pickup group

1. When you hear a call ringing at an extension, press the Pickup - directed key. Your display shows the name of the called station.

2. Select *Accept call?*

Refer to “Feature Access Codes” on page 39 for information on accessing features through special access codes.

Forwarding

Forwarding automatically redirects your incoming calls to another extension or an outside number. Forwarding lets you set up an extension or outside number for forwarding under conditions you specify.

To automatically forward calls

1. With your telephone idle, scroll to and select *Forwarding On?*.
2. You can then scroll to and select from the following options:
 - *1=All calls?*
Forwards both internal and external calls
 - *2=External calls only?*
Forwards all external calls
 - *3=Internal calls only?*
Forwards all internal calls
 - *Exit?*
3. Dial the extension or external number where you want your calls forwarded.
4. Select *Save?*.

To cancel Forwarding

When your telephone is idle, the display will show one of the following:

- all to: [the number or extension]
- int. to: [the number or extension]
- ext. to: [the number or extension]

With the telephone remaining idle, scroll to and select *Forwarding off?*.

Refer to “Feature Access Codes” on page 39 for information on accessing features through special access codes.

Hold

The Hold feature lets you place an active external call on hold without disconnecting the caller.

For this feature, you must set up one of your programmable feature keys as a Hold key (refer to “To program a feature key” on page 14).

To put a call on hold

After receiving or placing an external telephone call, press the Hold key to place the caller on hold.

To reconnect to a held call

After placing a call on Hold, you can return to the caller without replacing the handset by scrolling to and selecting *Return to held call?* or by pressing the flashing line key associated with the call.

Notes: If you do not retrieve the call after a certain time (determined by the communications server), the call will return to your telephone with triple rings. If you do not answer, the call may be transferred to the operator, if so configured on the communications server.

To place a caller on hold, the call must be associated with an outside call.

Refer to “Feature Access Codes” on page 39 for information on accessing features through special access codes.

Hold—Internal Consultation

This feature lets you place an intercom or internal/external call on exclusive hold. Upon activating this feature, you are limited in the following ways:

- you cannot replace the handset on the cradle
- you cannot place or receive additional calls
- you can only retrieve the call from your telephone

For this feature, you must set up one of your programmable feature keys as an Internal Consult key (refer to “To program a feature key” on page 14).

To put a call on hold

After receiving or placing an internal/external call, press the Internal Consult key to place the caller on hold.

To reconnect to a held call

If you want to retrieve the held caller, you press the Select key to choose the *Return to held call?* option.

Refer to “Feature Access Codes” on page 39 for information on accessing features through special access codes.

Last Number Redial—Expanded

Last Number Redial lets you quickly redial the last three external number you dialed. Each time you dial a valid external telephone number, it is automatically stored.

To redial numbers

1. Press the Redial key (the second default feature key from the top). The display shows the last number dialed. The system dials the number automatically if you do not proceed to step two.
2. If you want to dial the last number called, scroll to and select *Call?* or use the *Next?* option to scroll to and select either of the next two numbers.

To quickly redial internal numbers you can use the Caller List feature. (Refer to “Caller List” on page 19.)

Refer to “Feature Access Codes” on page 39 for information on accessing features through special access codes.

Mailbox / Text Messages

This feature lets you receive and answer reminder messages left on your telephone by internal callers and voicemail systems. Messages turn on the status light beside your Mailbox key (if programmed) and provide information about the call.

To display messages

1. The idle display will inform you of messages waiting, or your Mailbox key (if present) will be lit.

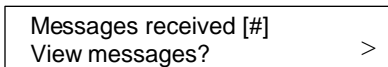

2. Press the Select key to choose the *View messages?* option.
3. Select *Message sent?*.
4. The next screen shows the first caller's message along with *Time/date sent?*.
5. Select *Time/date sent?* to choose from the following options, available by scrolling:
 - *Call sender?*
 - *Delete?*
 - *Next?* (if applicable)
 - *Previous?* (if applicable)
 - *Exit?*

Note: If the same person has called three times and left three different reminder messages, one return telephone call will delete all three messages. All messages will remain in the queue until they are deleted through the display or the sender is successfully called.

Note: Simply pressing the Mailbox key also displays the Mailbox prompts.

6. After displaying a message, scroll to *Next?* and select it if you want to see other messages.
7. To delete a message, scroll to *Delete?* and select it.
8. When finished, scroll to *Exit?* and select it.

To answer a displayed message

1. When the message you want to answer is displayed, scroll to *Call sender?* and select it.
2. The communications server calls back the party that left you the message. If the party answers, the message is deleted automatically.

To leave a reminder message

1. When receiving a busy tone, getting no answer, or from an idle state, scroll to *Send message?* and select it.
2. You can choose from the following default messages or with a Memory telephone you can create your own:
 - 0 = *Please call back?*
 - 1 = *Someone is waiting?*
 - 2 = *Appointment?*
 - 3 = *Urgent call?*
 - 4 = *Do not disturb?*
 - 5 = *Fax waiting?*
 - 6 = *Please come - dictation?*
 - 7 = *Please come see me?*
 - 8 = *Please make copies?*
 - 9 = *Leaving office?*
 - Type personal message?* (Memory telephone)
 - Previous Menu?*
 - Exit?*

Note: Your system administrator can change these messages, so yours may differ.

3. Scroll to *Send?* and select it. (If you have made a callback request, scrolling is not necessary.)
4. Hang up. The other party's Mailbox status light (if present) turns on. If the other party has a display telephone, the system will also leave a reminder message providing your name and the date and time of your call.

Note: If you leave a message while calling an unanswered telephone, you will also be added to the *Caller List?* for the extension.

Refer to "Feature Access Codes" on page 39 for information on accessing features through special access codes.

Park

Park lets you move a call to a temporary holding place (a system slot). Any internal party can then retrieve the call by selecting the parked slot and retrieving the call. If you do not retrieve the parked call, the system calls you back after a designated time. The amount of time a caller can remain in call park can be changed by the system administrator.

Note: For the feature described here, this procedure uses a Park key (refer to “To program a feature key” on page 14).

To park a call

1. During a call, press the Park key
2. Dial the slot number (0-9) where you want to park the call.
You will need this number to retrieve the parked call.

Note: If you pick a system slot that already contains a call in park, you hear a tone and the display remains unchanged. If this happens, you can try another slot.

To retrieve a parked call from any telephone

1. Press the Park key

or dial # 56.
2. Enter the slot number where the call is parked.

Note: If you have forgotten the slot number where you parked a call, the call will return after a system-programmed *Park timeout* expires.

Refer to “Feature Access Codes” on page 39 for information on accessing features through special access codes.

Pickup

Pickup features let you answer calls ringing or queued at other extensions.

Group Pickup lets you answer a call to an extension in your pickup group (set up at the communications server) even when you do not know the number for the extension. Pickup groups are set up at the communications server by a system administrator.

Station Pickup lets you answer a call at any extension.

To answer a call in your pickup group

When a call in your pickup group is received by the system, your display will read:

Call for: [Name and extension] Pickup - group? >

You can answer the first group call in the queue in the following ways:

- press the Select key
- press the button associated with the pickup group, next to the flashing LED (if present)

To answer a group call while on another call

1. Press the Select key for pickup

or press the button associated with the pickup group, next to the flashing LED (if present).

2. To go back and forth between parties, scroll to and select *Toggle?/Connect?*.

Note: You can also pickup a call at any extension, or you can transfer, place on hold, place on consultation hold, or park a call you have picked up. (Refer to “Directed Call Pickup” on page 24, “Transfer” on page 38, “Hold” on page 26, “Consultation” on page 23, and “Park” on page 31.)

Refer to “Feature Access Codes” on page 39 for information on accessing features through special access codes.

Repertory Dialing (Repdial) Keys

This feature lets you set up Repdial keys for one-touch dialing of an internal extension or an outside number. To set up a Repdial key, refer to “To program a feature key” on page 14.

After setting up the Repdial key, just press the Repdial key to automatically connect to the programmed number or extension.

Notes: If you assign a Repdial key for an external number, you must also enter an external access code (for example, 9). If you assign a Repdial key to an internal number, the key has the following functions in relationship to the corresponding station:

- Direct Station Select key
- off hook indicator
- ring indicator
- call hold indicator

Refer to “Feature Access Codes” on page 39 for information on accessing features through special access codes.

Saved Number Redial

This feature lets you save up to ten internal or external previously dialed numbers. After saving a number, you can then select it from the caller list, and the system dials the number.

To save a number you have dialed

After calling a number, select *Save number?* from your OptiGuide display before hanging up.

To dial your saved number

1. When the telephone is idle, scroll to and select *Caller List?*.
2. Select the number that you want to call from the list.

Note: With a two-line display, select *Next?* to scroll through the caller list; however, with the Memory telephone, use the *Up* and *Down* cursor keys.

3. Scroll to and select *Call?*.

Refer to “Feature Access Codes” on page 39 for information on accessing features through special access codes.

Speakerphone

The Optiset E Standard, Advance Plus, and Memory telephones have a two-way speakerphone, consisting of a speaker and a microphone. You can use either the handset or the speakerphone to make or receive calls. During a conversation, you can use your speakerphone instead of your handset by pressing the Speakerphone key (the bottom default feature key) and hanging up the handset. If you want to switch back to using your handset, pick it up.

To make a call

To make a call using the Speakerphone feature, do one of the following procedures:

- dial without lifting the handset to automatically activate the speakerphone and place the call.
- press a Redial key to automatically dial its programmed extension
- press the Speakerphone key to get a dial tone, then dial

To answer a call

Press the Speakerphone key and begin talking, or press the Redial key (if present) next to the blinking status light.

To hang up

To disconnect a speakerphone call, press the Speakerphone key.

To switch during a call

If you are using the handset and want to use the speakerphone, press the Speakerphone key and hang up the handset. If you are using the speakerphone and want to use the handset, pick up the handset.

Station / Individual Speed Dialing

This feature lets you assign frequently called external numbers to a code (*0 through *9). You can then dial this digit code instead of the entire telephone number. The Hicom 150 E CS allows a dialing sequence of up to 25 characters to be assigned to each digit code.

Note: For the feature described here, this procedure uses a Speed Dial key that is programmed by your system administrator.

To set up a station speed dial code

1. Dial * 92.
2. Dial a speed dial index code (*0 through *9) and select *Change?*.
3. Enter the dialing sequence that the code will represent. You may be required to include an access code for an external line.
4. Select *Save?* or to program a different speed dial code, scroll to *Next?* and select it.
5. When you are finished, scroll to and select *Exit?*.

To dial using a station speed dial code

To use the station speed dial feature, use the OptiGuide Display to follow these steps:

1. When your telephone is idle, press the Speed Dial key
or dial * 7.
2. Dial the station speed dialing index code.

Refer to “Feature Access Codes” on page 39 for information on accessing features through special access codes.

System Speed Dialing

If the System Speed Dialing feature is set up on your communications server, you can dial frequently called outside numbers (local, long distance, and international) by dialing a code number. Usually these codes are published for an entire company in a special system speed directory. Consult your system administrator if you do not know your system speed numbers.

Note: For the feature described here, this procedure uses a Speed Dial key that is programmed by your system administrator.

To make a system speed call

1. When your telephone is idle, press the Speed Dial key
or dial * 7.
2. Dial the system speed dialing code (000-299 or 000-999, depending on your system).

Refer to “Feature Access Codes” on page 39 for information on accessing features through special access codes.

Transfer

Transfer lets you send a call to another extension or to an outside number if your communications server is set up to do this.

To transfer a call

1. During a call, scroll to and select *Start transfer?*.
2. When you have dial tone, dial the extension, or dial 9 and the outside number. If you want, announce the caller when the party answers.
3. Hang up.

To reconnect

If the person you are trying to transfer the call to refuses to take the call, you can reconnect to the caller in the following two ways:

- You will automatically be reconnected to the initial caller when the refusing transfer party hangs up.
- Scroll to *Quit and return?* and select it. This rejoins you to the caller and releases the non-consenting party.

To toggle between parties

If the person you are trying to transfer the call to wants more information before accepting the call, you can toggle between the two calls.

1. Scroll to and select *Toggle/Connect?*. This rejoins you to the caller.
 2. Select *Toggle/Connect?* again to return to the second party.
- Refer to “Feature Access Codes” on page 39 for information on accessing features through special access codes.

Feature Access Codes

The table below lists the features that can be activated (*) and deactivated (#) by dialing feature access codes.

Feature	Activate	Deactivate
Account code (max. 11 digits)	*60+ACCT	
Busy override	* 62	
Call forwarding - all calls	*11+Stn. no.	# 1
Call forwarding - external	*12+Stn. no.	# 1
Call forwarding - internal	*13+Stn. no.	# 1
Call pickup, directed	* 59+Stn. no.	
Call pickup in PU group	* 57	
Callback, initiate/view, cancel	* 58	# 58
Caller list, display/write to, save station number	* 82	# 82
Change pin code	* 93 +Old code +New code +New code	
Conference	* 3	# 3
Consultation hold, exit (return to held call)	* 0	
Do not disturb	* 97	# 97
Group ringing	* 81+Stn. no.	# 81
Handsfree answerback	* 96	# 96
Hunt group on/off Group call on/off	* 85	# 85
Key programming	* 91	
Microphone mute	* 52	# 52
Night answer	*44+Stn. no. or *44*	# 44
Park	*56+Park slot (0-9)	# 56+Park slot (0-9)
Release trunks	* 43+Trunk	
Reset all services	# 0	
Retrieve external call placed on hold by means of hold key	* 63+Trunk	
Ringer cutoff	* 98	# 98
Room monitor	* 88	
Send message/call sender		# 683
Send message/delete all messages sent		# 682
Send message/delete all messages sent or received		# 680
Send message/delete message		# 68
Send message/display message	* 68	
Silent camp-on	* 87	# 87
Silent monitoring (USA only)	*944+Stn. no.	
Speaker call	* 80+Stn. no.	
Station number, assign for MUSAP	* 41+DID no.	
Station number suppression	* 86	# 86
Station speed-dialing number, save/change	* 92+ISD no. (*0 - *9)	
System administration	* 95	
System speed-dialing (SSD)/station speed-dialing (ISD), dial	* 7+ISD no. (000-999) (000-299 with OfficePoint)	
Telephone lock, individual	* 66+Code	# 66+Code
Telephone test	* 940	
Toggle	* 2	
Tone dialing	* 53	
Trunk flash on analog trunk	* 51	

Index

A

- access codes 14
- Analog Adapter 6
 - power supply 10
- assistance. *See* system administrator

B

- Bay option modules 6
 - installation 8
 - Optiset E Analog Adapter 6
 - power supply 10
 - Optiset E Control Adapter 7
 - Optiset E Data Adapter 6
 - Optiset E Headset Adapter 6
 - Optiset E Headset Plus Adapter 7
 - Optiset E ISDN Adapter 7
 - Optiset E Phone Adapter 7
- busy tone 16

C

- callback request 18
- Caller 19
- caller list 19
- changing audio settings 17
- class of service 11
- company speed dialing. *See* system speed dialing
- conference 20
 - adding calls 20
 - dropping a party 22
 - setting up 20
- confirmation tone 16
- consultation hold 23
 - toggle 23
- Control Adapter 7
- COS. *See* class of service

D

- Data Adapter 6
- direct station select key 33
- directed call pickup 24
- DSS key *See* direct station select key

E

- error tone 16

F

- feature access codes - list 39
- feature keys 14
 - programming 14
- forwarding 25
 - all calls 25
 - external calls 25
 - internal calls 25
 - to external number 25
 - to internal extension 25

H

- Headset Adapter 6
- Headset Plus Adapter 7
- hold 26
- hold *See also* consultation hold
- hold—internal consultation 27

I

- individual speed dialing. *See* station speed dialing
- internal consultation 27
- ISDN Adapter 7

K

- Key Module 9

L

- last number redial 28
- list - feature access codes 39
- LNR. *See* last number redial

M

- mailbox 29
- main menu 12

O

- OptiGuide display 12
 - OptiGuide keys 12
- OptiGuide keys 12
- Optiset E Advance Plus telephone 3
 - option module bays 3, 6
 - installation 8
 - Optiset E Analog Adapter 6
 - Optiset E Control Adapter 7
 - Optiset E Data Adapter 6
 - Optiset E Headset Adapter 6
 - Optiset E Headset Plus Adapter 7
 - Optiset E ISDN Adapter 7

Optiset E Phone Adapter	7
Optiset E Key Module	9
Optiset E Key Module options	3
Optiset E Memory telephone	4
alphanumeric board (Qwerty)	4
Electronic Notebook	4
Optiset E Standard telephone	2

P

park	31
retrieve	31
Phone Adapter	7
pickup	
group	32
station	32
program/service key	14

R

reminder messages	29
answering	30
leaving	30
viewing	29
redial keys	33
setting up	33
repertory dialing. <i>See</i> redial keys	
ringing	16

S

saved number redial	34
Service/Program Key	12
sounds	
ringing	16
tones	16
speakerphone	35
station speed dialing	36
setting up	36
status lights	11
flash rates	11
system administrator	11
system speed dialing	37
PIN	37

T

tones	16
transfer	38
toggle	38

V

voice volume keys	15
-------------------	----

volume keys 15

changing audio settings 17

Quick Reference Guide to Optiset Phones

Important Note: Depending on the active/inactive state of your telephone you may need to Select *Consult?* to get dial tone before dialing a code.

Important Note: If you have an analog telephone, you may need to dial 7 5 instead of * or 7 6 instead of #.

Transfer a call: Select *Consult?*. Dial the number. Announce the call and hang up.

Consultation calls (short hold): Select *Consult?*. First call goes on hold. Dial the new party. Speak. Hang up (or toggle) to return to first call. To put a call on hold, select *Consult?*.

Toggle/Connect: To reconnect to a call on consultation hold, select *Toggle/Connect?*.

Callback: To place a callback, while the telephone you called is ringing or busy, dial * 5 8.

To delete all callbacks, dial # 5 8.

Conference: Begin with an ordinary call. Make a consultation call, then dial * 3 to join all in a conference. Repeat for up to five members. To end a conference dial # 3.

Do Not Disturb: Dial * 9 7. You can still make outgoing calls and set callbacks.

Allow incoming calls: Dial # 9 7.

OptiPage: Dial * 8 0 and the zone code _____. Speak then hang up gently.

Forwarding: To forward all your calls to another extension dial * 1 1 (extension number).

To cancel forwarding: dial # 1.

Park (long hold): To park a call, tell the caller to hold. Dial * 5 6. Dial a system slot number(0-9). Hang up. The call will recall to you if not retrieved.

Retrieve a parked call: Dial # 5 6 and the system slot number (0-9).

Call Pickup: Dial * 5 9 and the extension of the ringing telephone.

Group Pickup: Dial * 5 7 to be connected to a ringing telephone in your group.

Call Waiting: When you hear the tone, hang up and answer the new call. Or, press the select key to accept the call without hanging up.

Individual Speed dial: Dial * 7, then enter the speed dial code. Individual speed dial codes are single digits preceded by * (*0-*9).

To set up individual speed dial numbers: dial * 9 2, then a code (*0-*9), and an external telephone number.

Station Speed Dial Numbers

*0	
*1	
*2	
*3	
*4	
*5	
*6	
*7	
*8	
*9	

System Speed dial: Dial * 7, then enter the speed dial code.
Company speed dial codes are three digits (000-299 for OfficePoint or 000-999 for OfficeCom and OfficePro).

Important Note: If you have a display telephone, your OptiGuide display will guide you through most of these functions. Use the scroll and select keys to choose features.

For details on all of these functions, please refer to the *Optiset E Telephones for Hicom 150 E Administrator Guide* (G281-0460-00).